



**LIGHT
DISCRIMINATION
APPARATUS**

USER'S
GUIDE

Model
14011A



Congratulations!

You have just acquired an innovative, high quality product. We have put our highest effort into each development stage. We are sure that you will find this equipment most reliable and accurate - exceeding your expectations.

Before using this device, we strongly recommend that you carefully read the user manual. There you will find all related information for correct handling and usage of this product.

We hope that you enjoy using this equipment as much as we did creating it.

De la Rosa Research Team.



INDEX

Pag.

7

Details

Pag.

9

Specifications

Pag.

11

Applications

Pag.

13

Features

Pag.

19

Procedure



DETAILS

The Light Discrimination Apparatus illustrates the various psychophysical methods (limits, average error, constant stimuli, etc.) used in visual discrimination. By watching the two 1.375" diameter light stimuli while the examiner adjusts light intensity, the subject's task is to determine when lights are at an equal intensity or when one light is more or less bright than the other. Each stimulus can be independently adjusted for diverse light intensity by subject or examiner. Light stimulus are presented using calibrated high intensity LEDs, therefore relative differences between the two stimuli are very low and highly reliable.



SPECIFICATIONS



Line Voltage: 110/220 VAC - 50/60 Hz



Stimulus Lamp: 2 x Warm light High intensity LEDs. 3500 K CCT (3220K - 3710K), CRI: Minimum 80 (x2), Typical 85 (x2) Flux 67 - 80, 160 - 120 degrees of viewing angle.



Supplied with User Guide

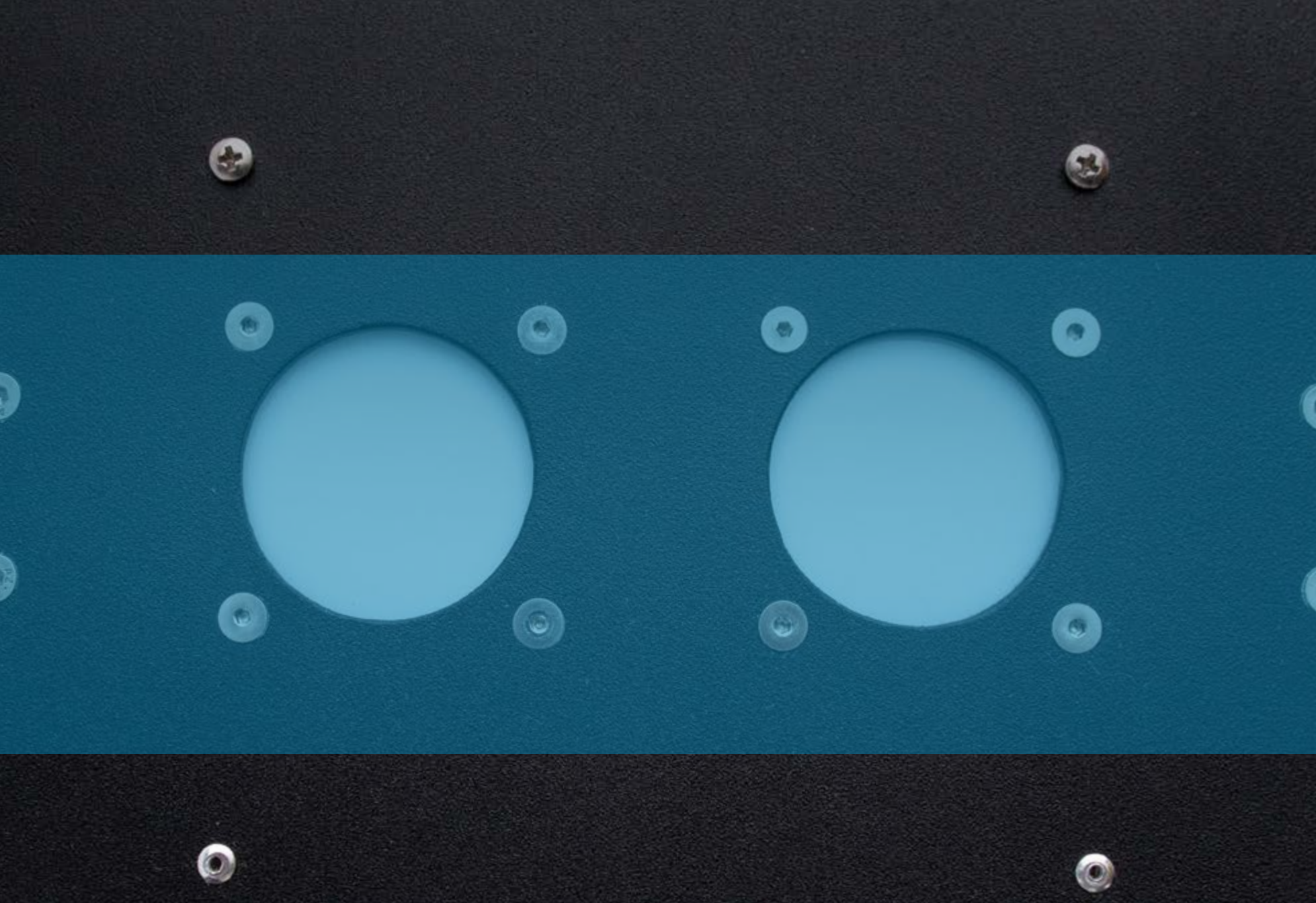

APPLICATIONS

Discrimination of light is a critical ability in daily life. Furthermore, light discrimination is critical to artists, photographers, illumination technicians, and movie directors. It is also a critical ability among Pilots, Air Traffic Controllers and Firefighters among others. The subject's task is to evaluate two stimuli lights (calibrated) to either judge if they match or differ. The system provides a LUX measurement of each presented light, and that allows the evaluator or researcher to obtain a good measure of the light discrimination accuracy. This equipment is also a great tool for demonstrations in the classroom or experimental lab. Recommended for demonstrations in psychology (sensory and perception), physiology and related courses.



FEATURES



Quality



Durable



Recyclable
materials

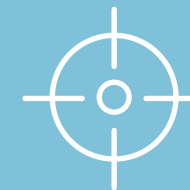

Accurate

FEATURES

FRONTAL PANEL

2 x independent LUX metering ICs.
256 steps LED control (8 bits).
Smooth (non noise cued) LED control paddle.
Acrylic window for high resistance and safety.



BODY

Black coated electrostatic painting for cue less distraction, high durability and easy maintenance.

Built from high-quality components manufactured in USA, Japan, Germany, Italy, etc.

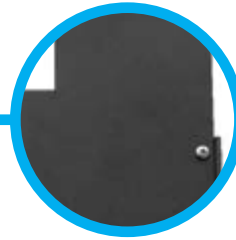

CONTROL

LCD and key pad control
Easy to read LCD display
Allows for time and accuracy measurements.
LUX measurement on final adjustment (Independent window measurement) for meaningful data generation.



MATERIALS

Aluminium - Stainless steel and acrylic body for study usage.

High resistance (and 100% recyclable) polymer base, easy to clean.



FEATURES

HANDLE

Ergonomic handle for easy carrying.



USB PORT

USB port for serial communication
(The software will be available soon and supplied at no charge).



POWER SOURCE

Medical Grade power source (short circuit protected through reprogrammable fuse).



MATERIALS

Adjustable main body for matching subject viewing angle relative to his/her height (exclusive feature) and viewing comfort.

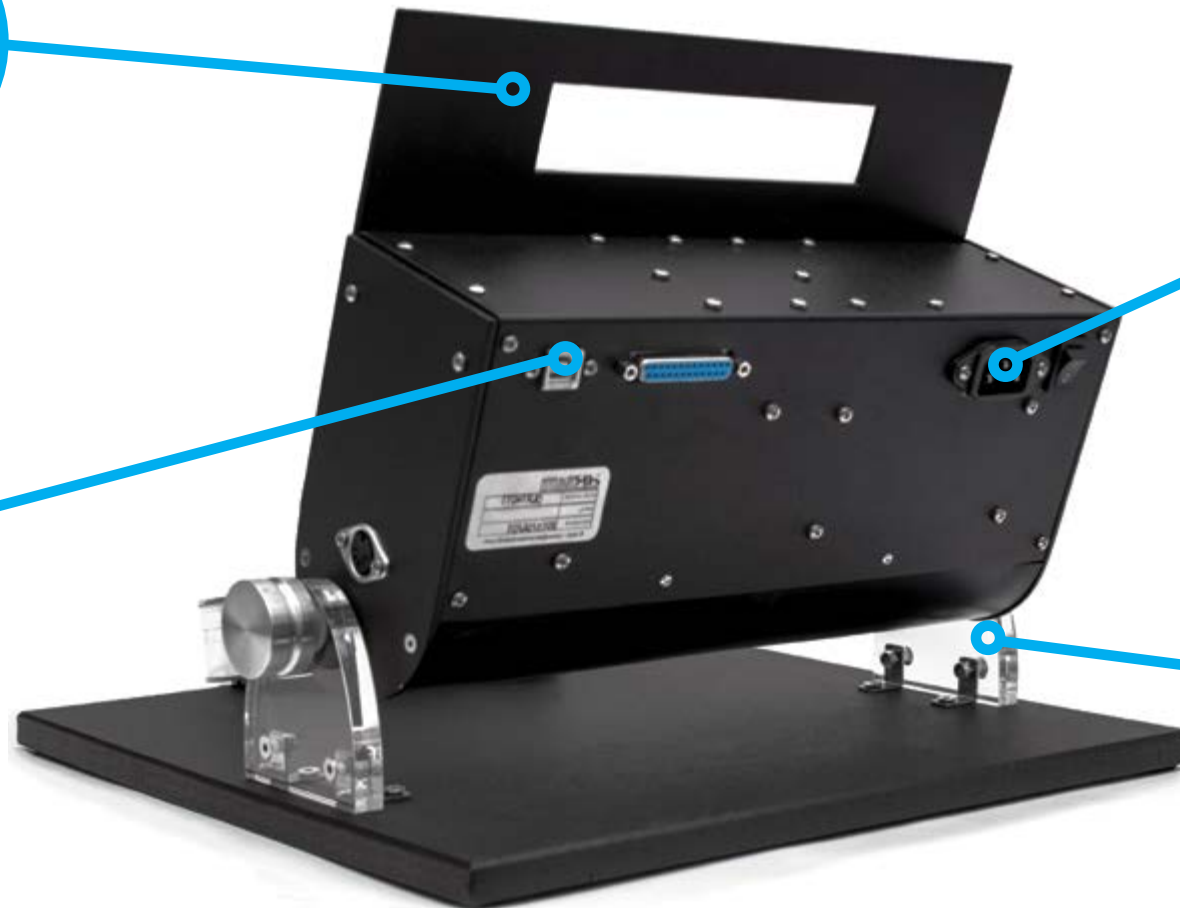
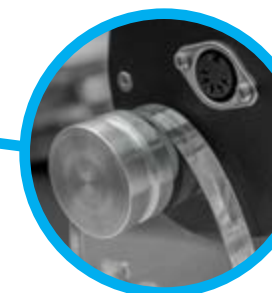



PROCEDURE



General recommendations



Initial settings



Test time

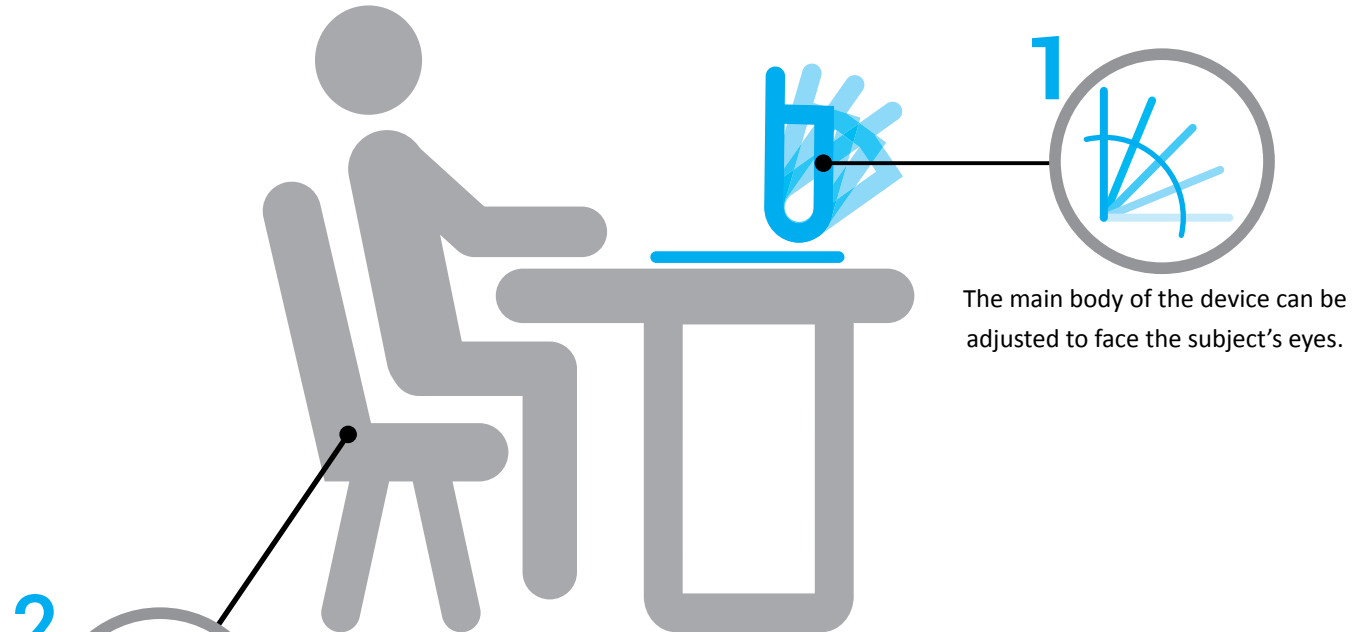

The main body of the device can be adjusted to face the subject's eyes.

2
Subject should be sitting in a comfortable chair in front of the desk where the equipment is set up.

! To avoid light interference, we suggest turning off the light or at least dim to minimum intensity. 

PROCEDURE

// GENERAL RECOMMENDATIONS



Avoid using sharp objects with the product.



Always ensure the proper power input.



Protect the product from rain and water.



Do not try to fix or disassemble this product by yourself.

! In case the product is not working properly, is damaged or needs maintenance, please contact us. We will gladly help you to solve any issue.

1 // WHAT SHOULD BE INCLUDED IN THE PACKAGE?

a.
x1

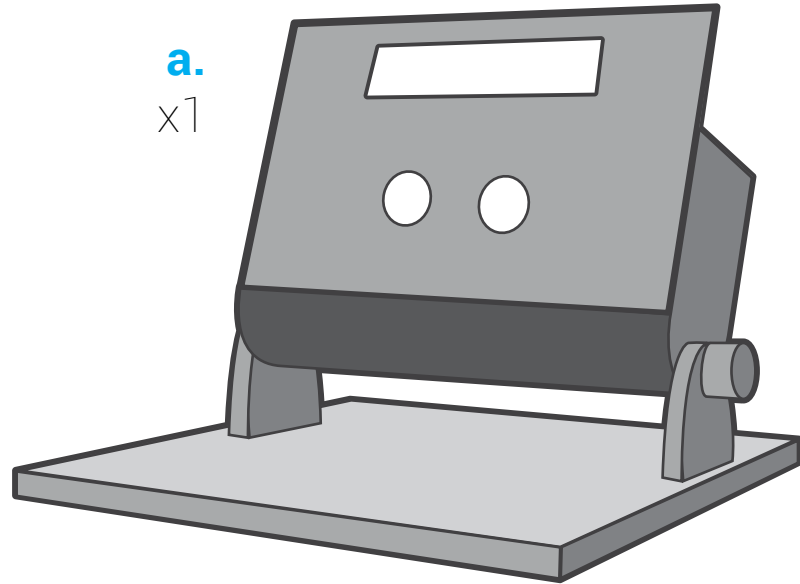

b.
x2

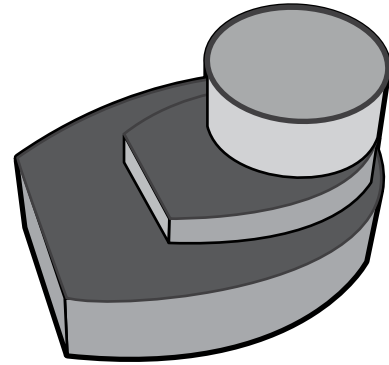

c.
x1

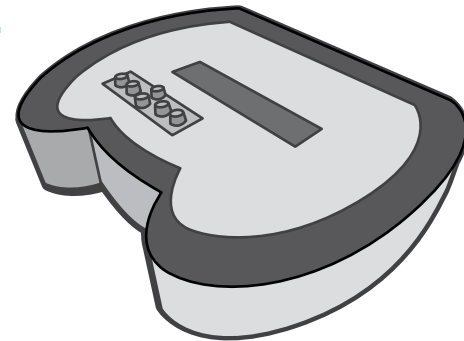

a. Light discrimination apparatus x1 // **b.** Knob Control x 2 // **c.** LCD control x 1 // **d.** DIN 5 cable x 2
e. Serial cable DB25 x 1 // **f.** USB cable A-B x1 // **g.** Power cable (AC cable) x 1.

d.
x2



e.
x1

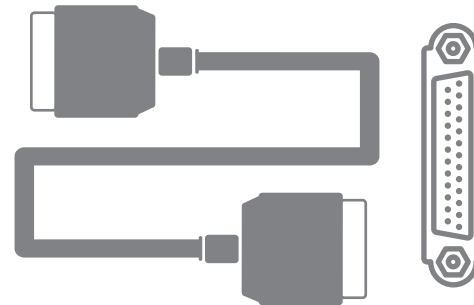

f.
x1



PROCEDURE // INITIAL SETTINGS



g.
x1

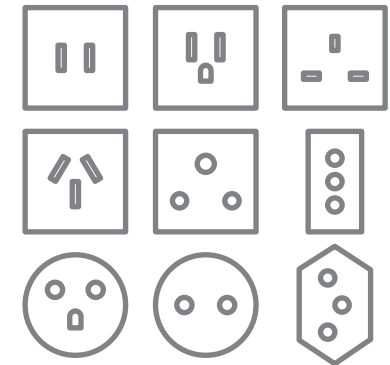
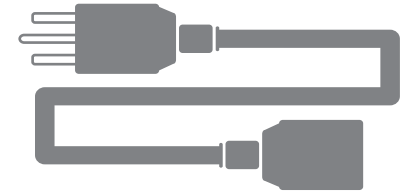

Depending on the geographical area, you will be given one of these AC cables (one per package).



2 // HOW TO ASSEMBLE?

SERIAL DB25 CABLE

Connect the male end of the Serial DB25 cable (e) to this port. The female end of the cable should be connected to the LCD control (c).

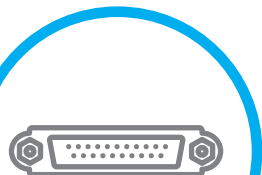

USB CABLE

USE ONLY IF USING CONTROL SOFTWARE.
The smallest end B of the USB cable (f) should be connected to this port. The opposite end of cable A should be connected to a computer USB port.

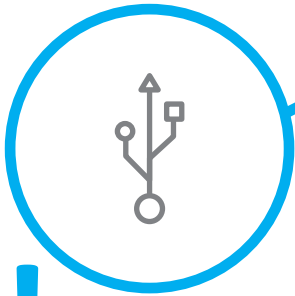

This USB cable has two different ends:



AC POWER CABLE.

Connect the AC cable (g) to this port. The opposite end should be connected to a 110/220VAC - 50/60Hz power outlet.



DIN 5 CABLE

Connect the male end of any DIN 5 cable (d) to the Left DIN 5 female left side connector. The opposite end of the cable should be connected to one knob control (b). Repeat the process with right side connector. *Knob controls work in both DIN 5 inputs.

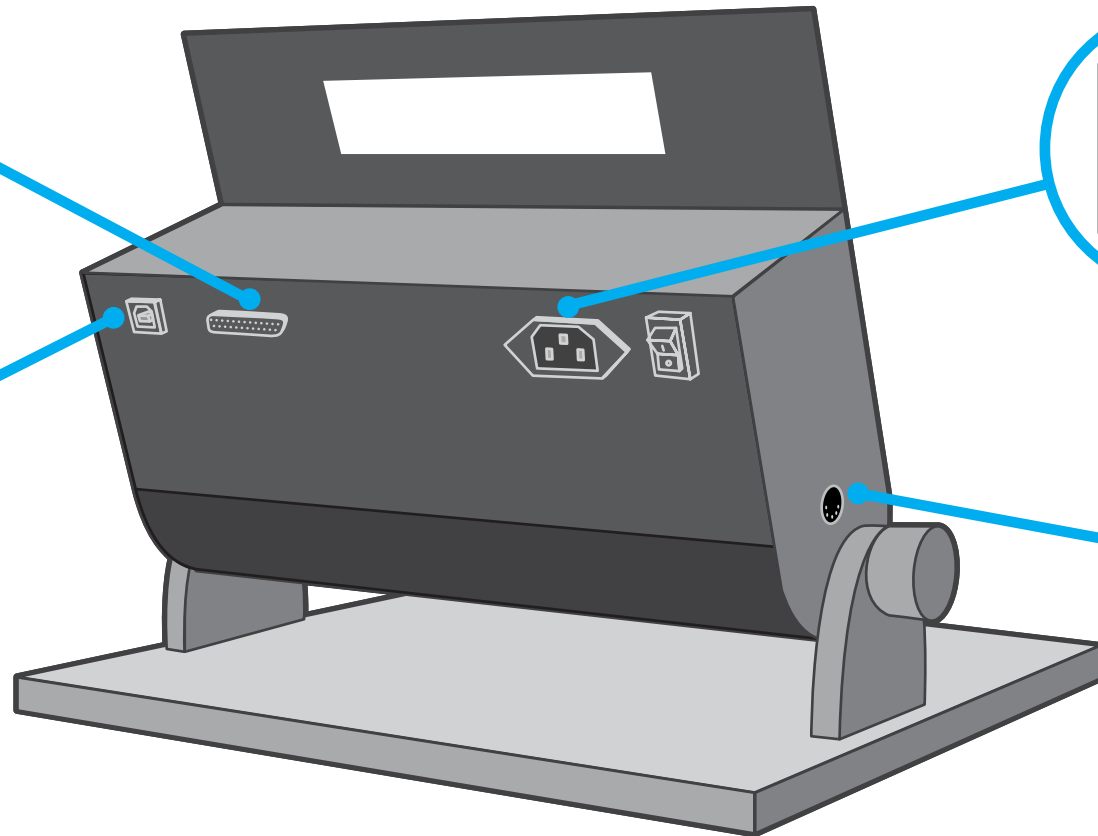

PROCEDURE // INITIAL SETTINGS



3 // WHAT DOES IT MEANS?

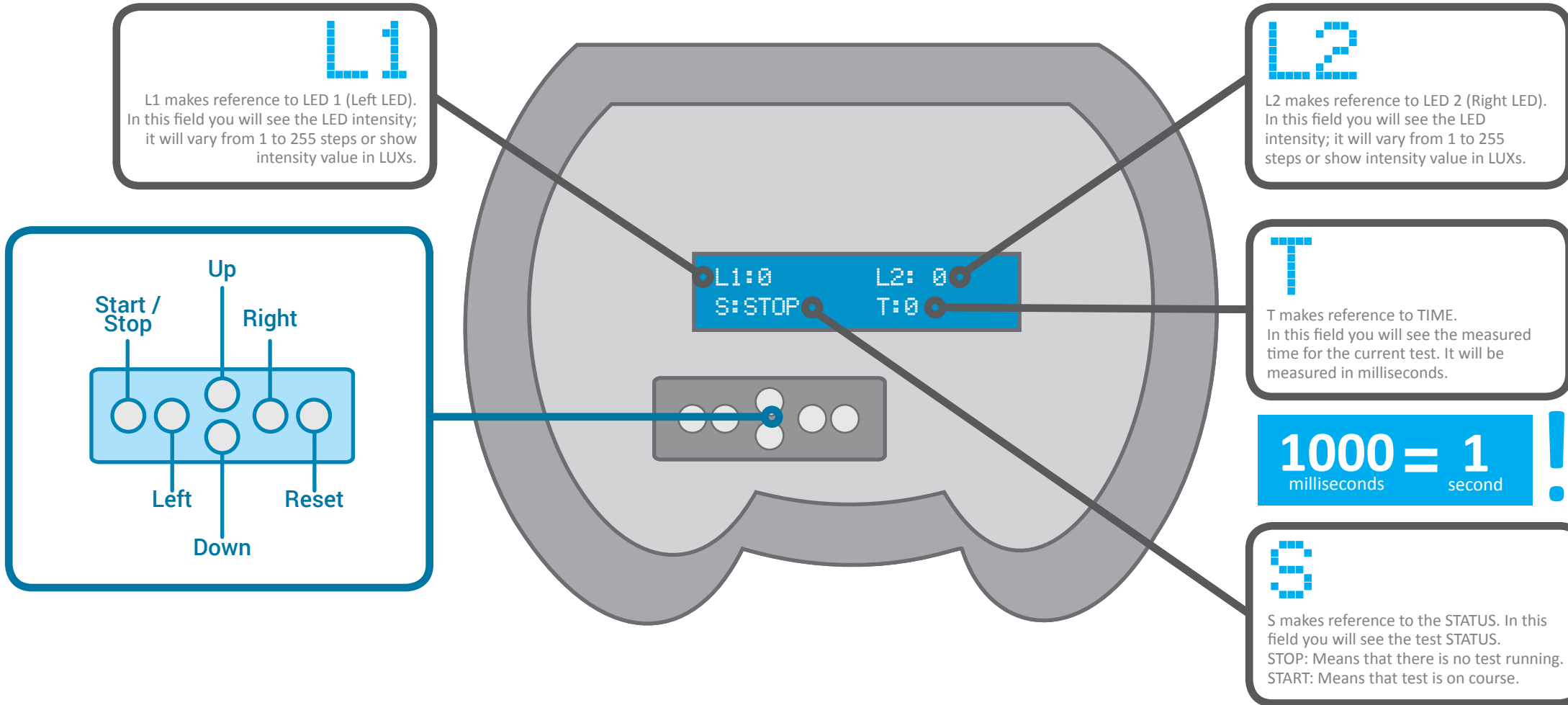

PROCEDURE // INITIAL SETTINGS



FAMILIARIZE WITH STATUS CODES

SLVL1
Select Level Value for LED 1

MLUX1 / MLUX
Intensity LUX value for LED 1 and LED 2

1 // STARTING A TEST.

Select Left LED intensity value.

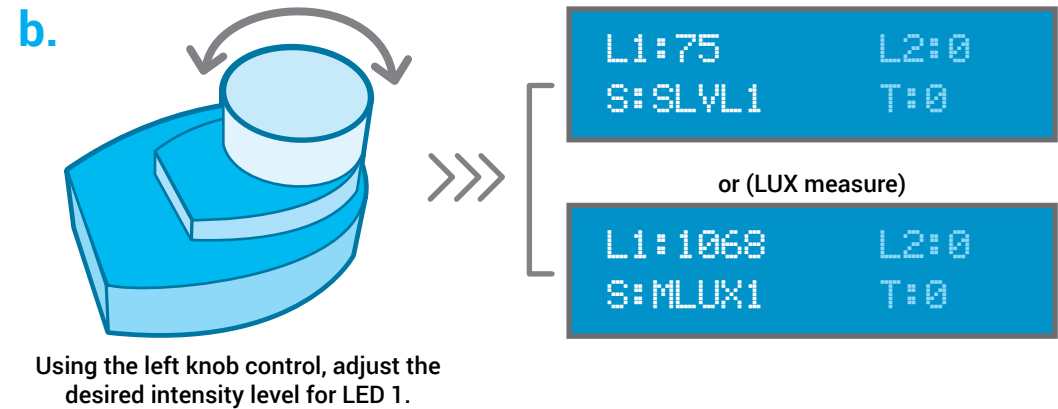
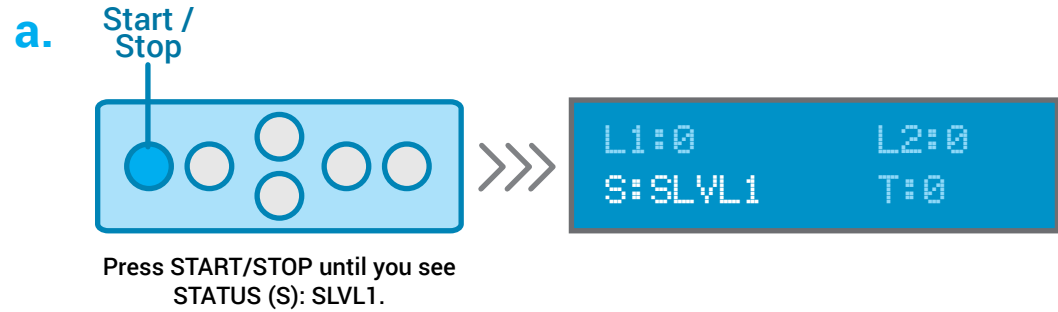

If you want to see the equivalent LUX measure, press UP until you see STATUS (S): MLUX1. Now L1 will show intensity value in LUXs. (From 0 to +/- 3000).

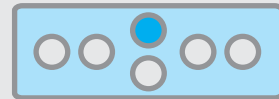

S:MLUX1

Allow the subject to start the test.

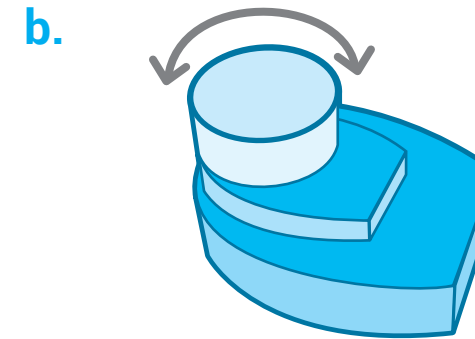
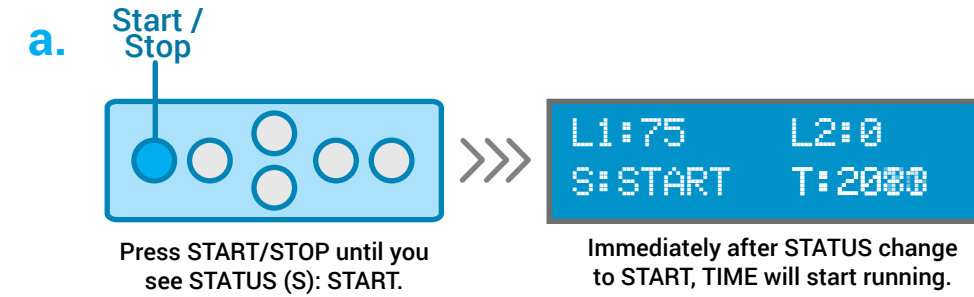

At this point, subject will be able to use the right knob control to adjust the right LED intensity level.

PROCEDURE // TEST TIME



Before starting the test, be sure that STATUS (S): SLVL1.

If STATUS (S):MLUX1, press the DOWN button until you see STATUS (S): SLVL1

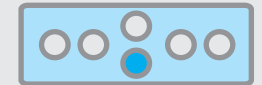

LLCD control should be managed by evaluator only. Remember that subject should not see the LCD control screen to ensure accurate results.

2 // ENDING A TEST // STARTING A NEW TEST

a. Start / Stop

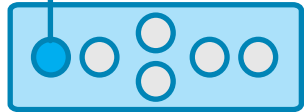

Press START/STOP until you see STATUS changing to STOP. TIME will stop immediately.



L1:75 L2:35
S:STOP T:16082

Remember that the time has been measured in Milliseconds.
1 sec = 1000ms.

b.

To start a new test, STATUS should be on STOP. If S is MLUX, press DOWN button, until you see STATUS (S): STOP.

L1:75 L2:35
S:STOP T:16082

c.

Press SART/STOP. STATUS will become SLVL1.



L1:0 L2:0
S:SLVL1 T:0

Both LEDs will turn off and Left Knob control will be available to adjust Left LED value once again.



BE CAREFUL!

If you have not taken note of the results and you press START/STOP, the data will be lost and there is no way to recover it. In this case you will need to apply the test once again to the subject.



THIS IS THE END OF THIS USER GUIDE.

This is all the basic information you will need for using the LIGHT DISCRIMINATION APPARATUS; but this is just the beginning of the fun.

If there is something that is not clear to you, or if you have any questions, please feel free to contact us at any time.

We will be very happy to hear from you.

support@delarosaresearch.com

(+57 1) 6275686

(+57) 3003642343

Cll 147 A # 48 - 08. Bogotá, Colombia

2550NW 72nd Ave. Suite 115. Miami, Fl. 33122.

De la Rosa Research Team.



support@delarosaresearch.com
(+57 1) 6275686
(+57) 3003642343
Cll 147 A # 48 - 08. Bogotá, Colombia
2550NW 72nd Ave. Suite 115. Miami, Fl. 33122.